



## PEB – Fabrication – Machinery



**PEB Works**



**SS & MS Fabrication**

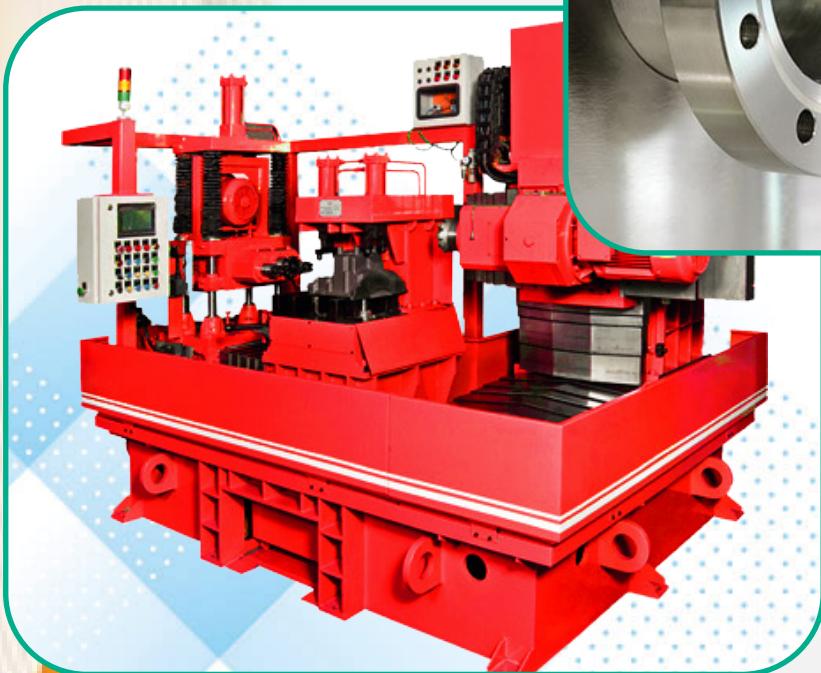

**SPECIAL MACHINES**

# PEB WORKS

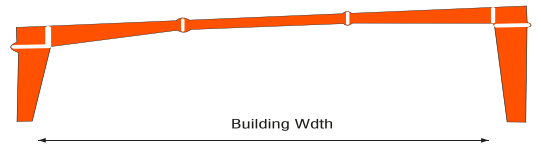
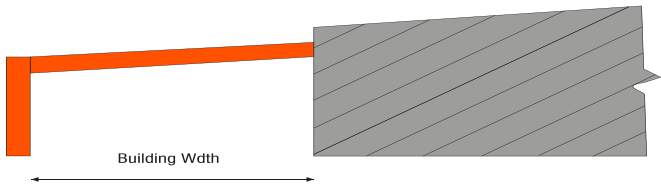
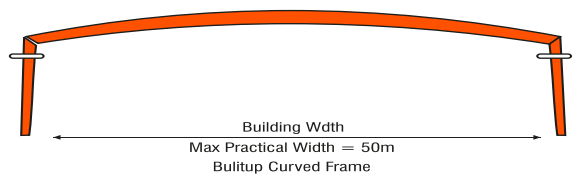
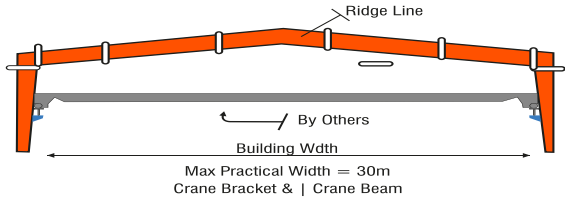
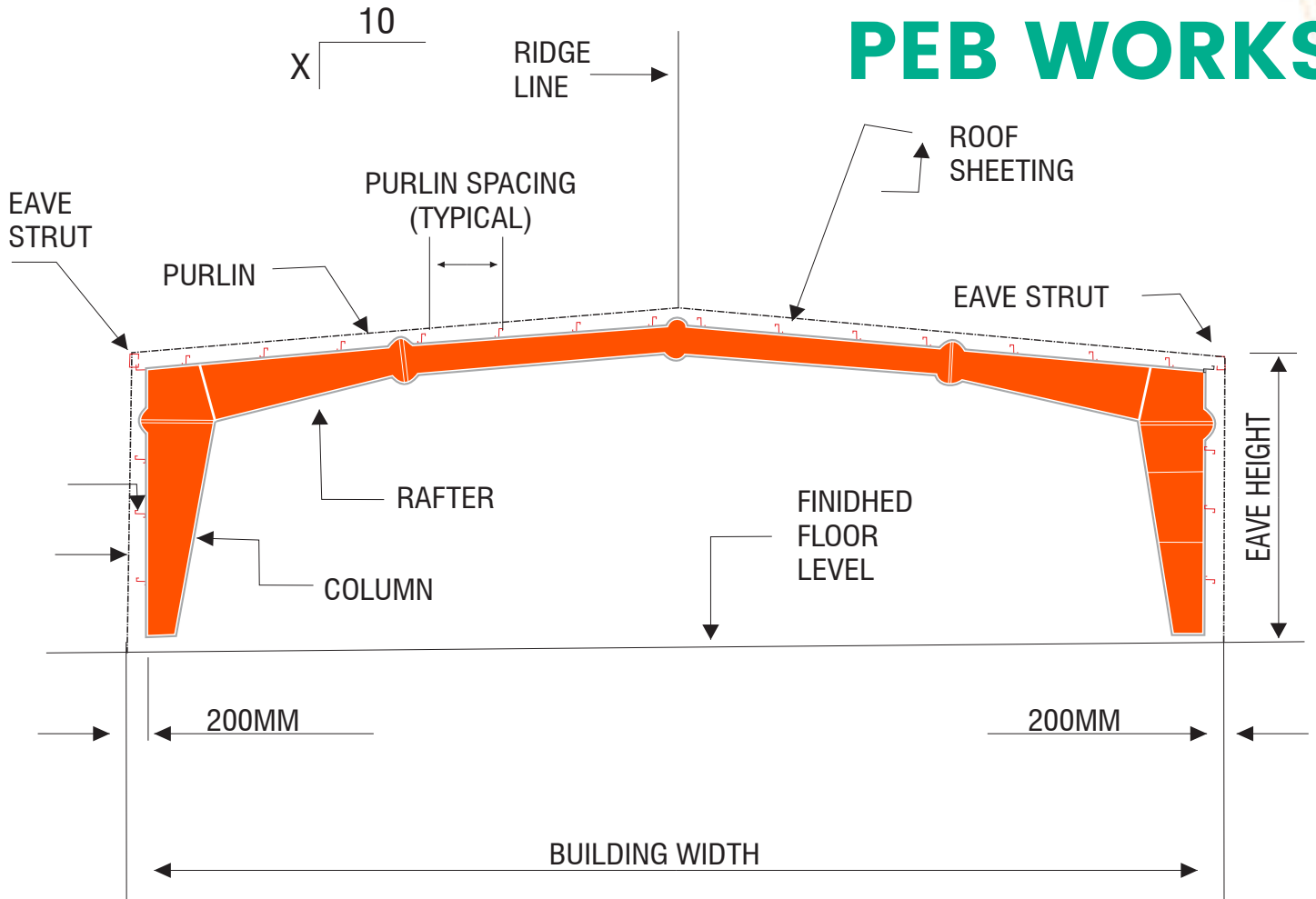

**Lean-to**

**Mono Slope**

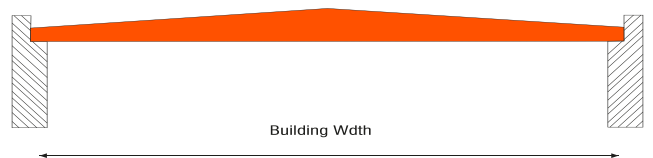
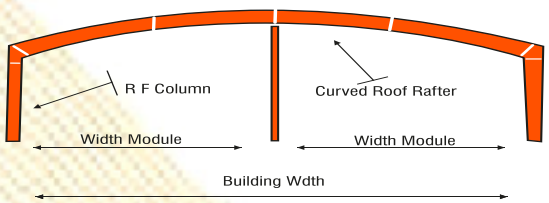

**Arched Multi Span**

**Roof System**

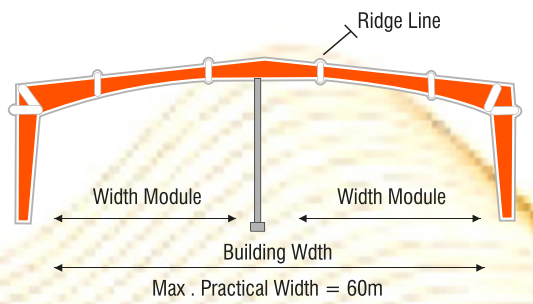
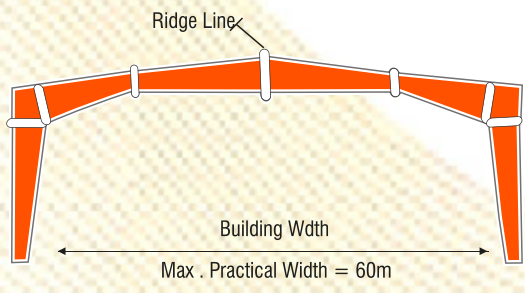

**TAPERED COLUMN CLEAR SPAN (TCCS)**

**TAPERED COLUMN MULTI SPAN "1" (TCMS)-1**

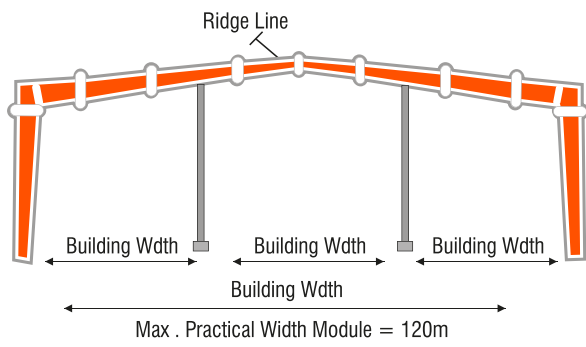

**TAPERED COLUMN MULTI SPAN "2" (TCMS-2)**

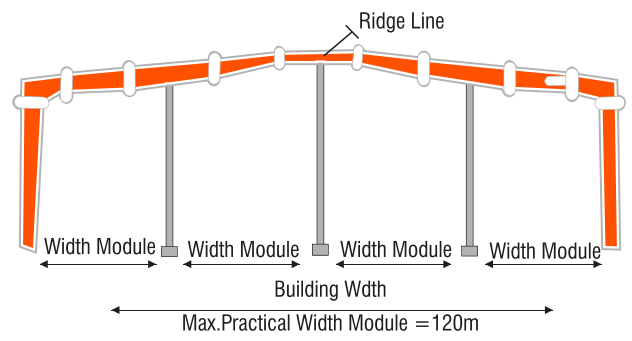

**TAPERED COLUMN MULTI SPAN "3" (TCMS-3)**

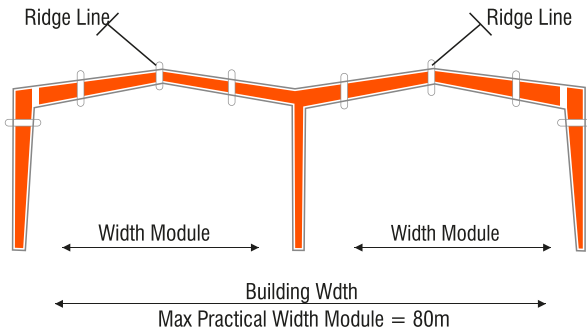

**Multi Gable (MG)**

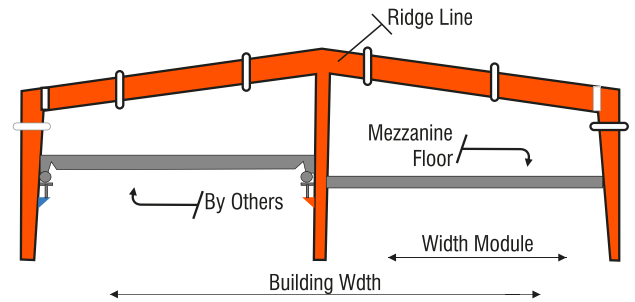

**Crane Bracket & | Crane Beam / Mezzanine Floor Provision**

**Anchor Bolt**

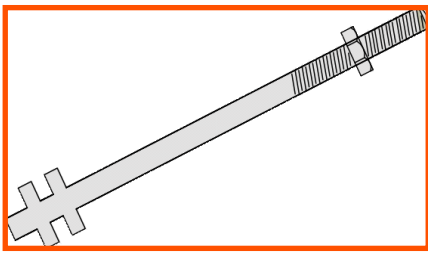

**Column**

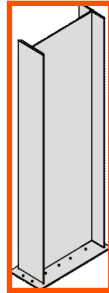

**Rafter**

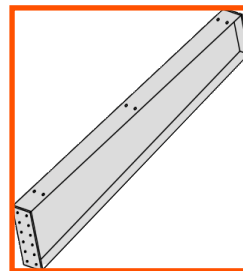

**Ramji Purlins**

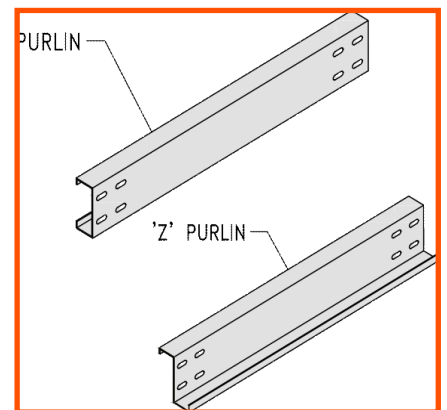

# ROLLER DOOR & SLIDING DOOR



**Roof Sheet**



# STRUCTURAL SUBSYSTEMS

PROTECH PEB Construction:- Pre engineered steel buildings can be fitted with different structural accessories including mezzanine floors, canopies, fascia, interior partitions etc. Fascia is used to conceal the gable roof slop of building. Arkotech Pre-engineered steel buildings can be fitted with different structural accessories. The Buildings made up of Steel where different components of the building are designed, detailed and fabricated in the Manufacturing unit, shipped to and erected at the site. These are provided at the eave level of the roof. This action safeguards the roof and imparts a show-room like appearance to the construction. Following are Different Types of Fascia Used In PEB Construction.

- Canopy
- Curve Eave with projection
- Curved Eave without projection
- Parapet Fascia
- Vertical Fascia with back up Panel
- Top & Bottom Curved Fascia
- Mezzanine Beam Connection
- Mezzanine Joist Connection

## PARAPET FASCIA

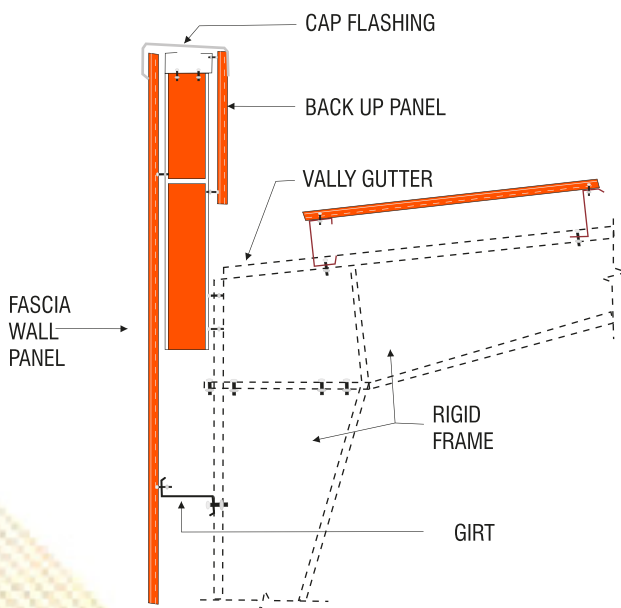

## VERTICAL FASCIA WITH BACK UP PANEL

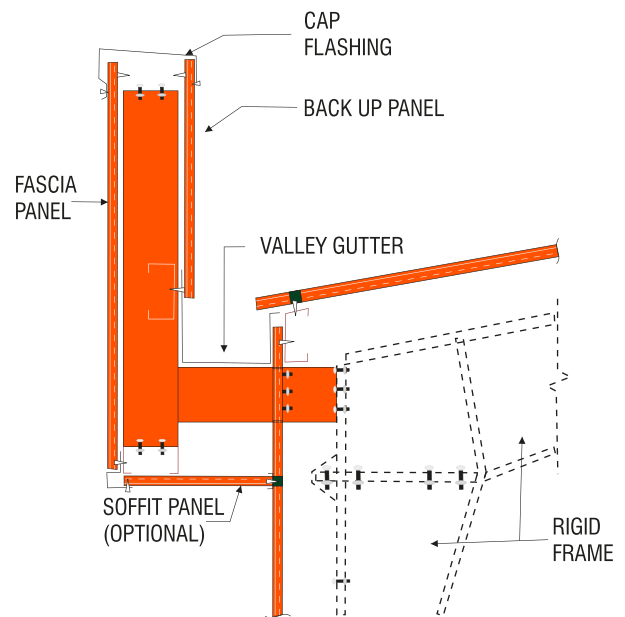

## CANOPY

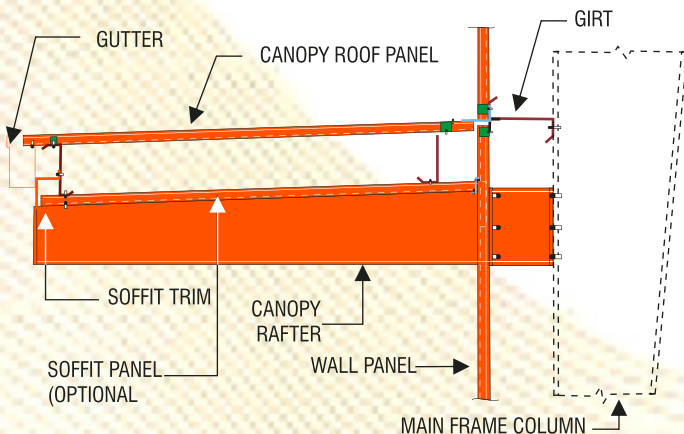

## EAVE CURVED WITH PROJECTION

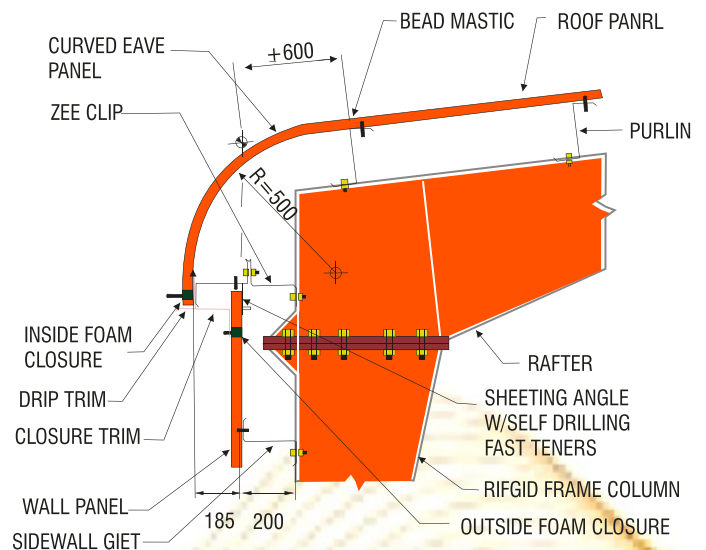

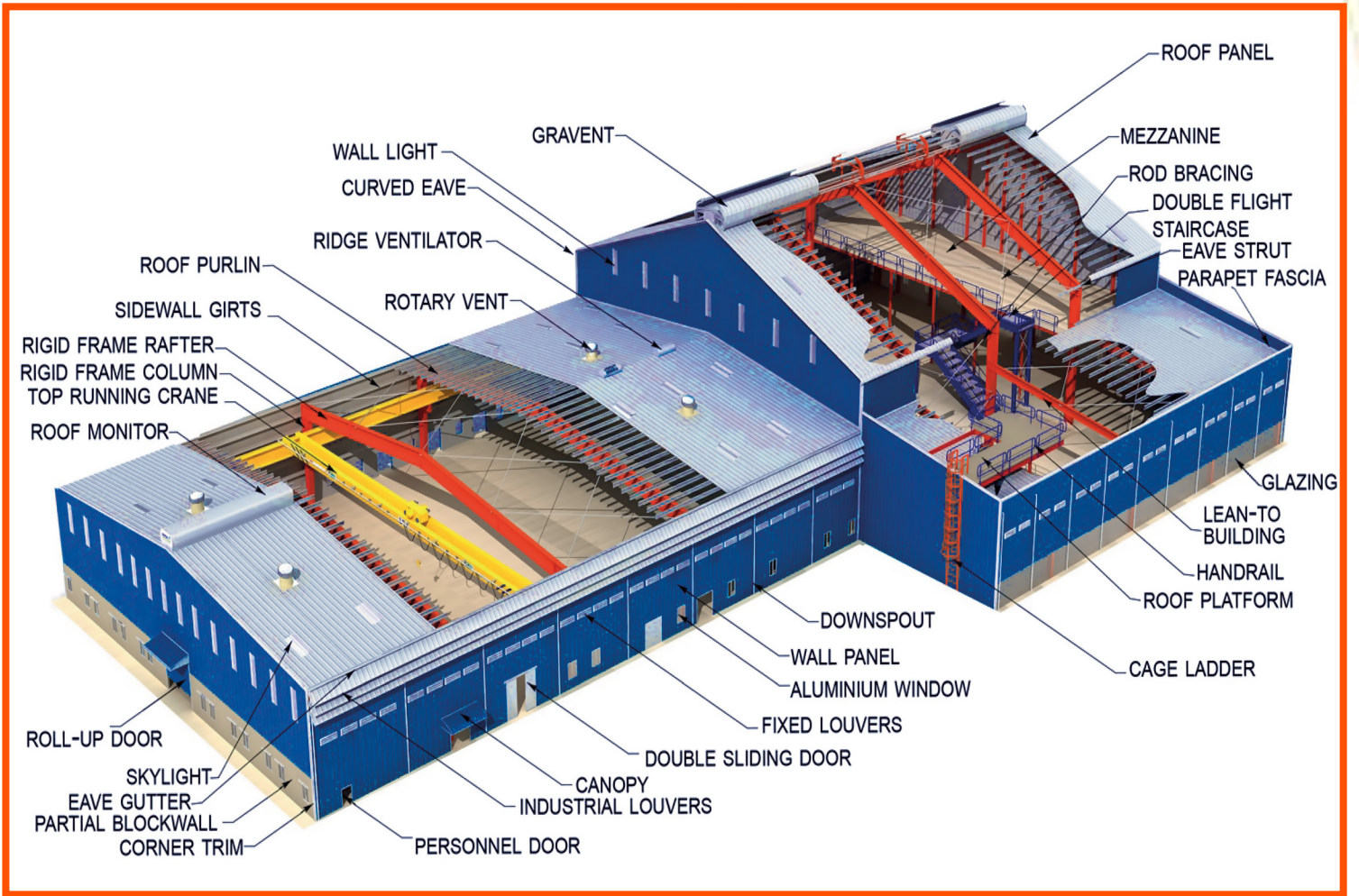

# SS & MS FABRICATION



## SS & MS Work

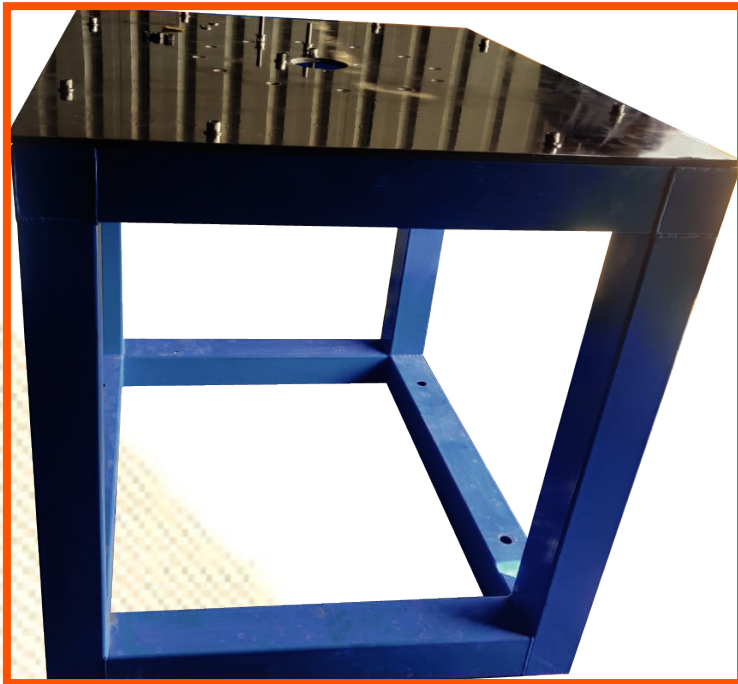

# OUR WORKS

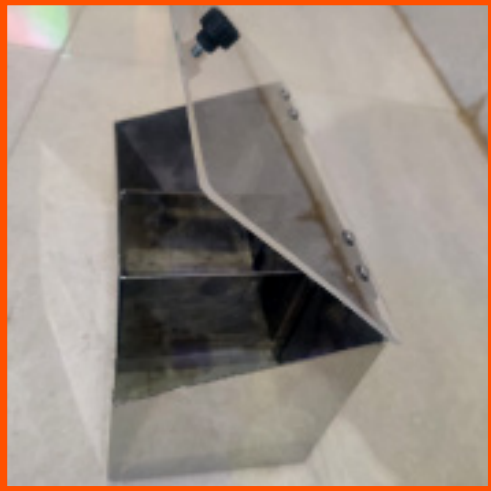
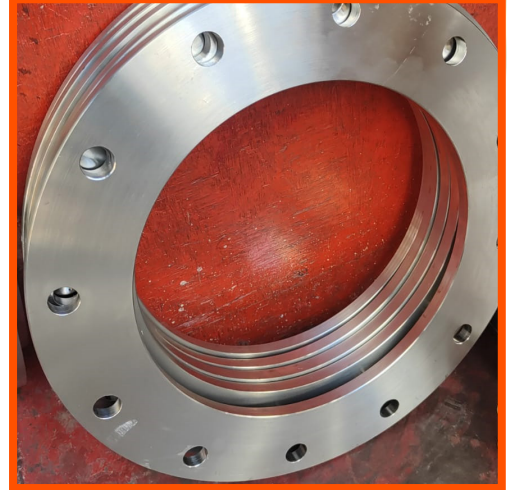

# Customized Machine

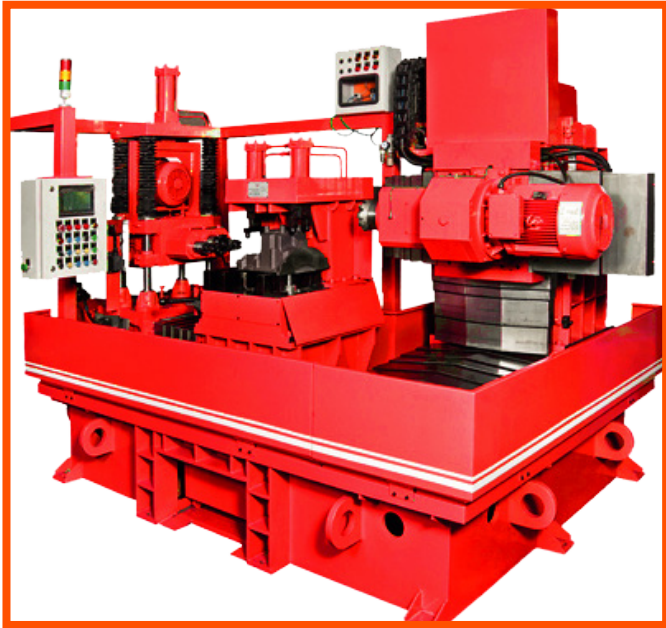

Supporting Work



# Rain Guard & MS FABRICATION



# Our Clients



## Thank You !!!

For Your Support



# VARNIKA

Ph: 9047672382

Mail ID: varnika219@gmail.com

GSTIN : 37KJAPS1906N1ZN

ACCOUNT HOLDER'S NAME: VARNIKA

BANK NAME: PNB, TADA BRANCH

ACCOUNT NO: 2238102100000227

IFSC CODE: PUNB0223810

📍 No: 09, Tada, Tada Bus Stand, Tirupati Dt, AP-524401.